

VARIO d2 ORIGINAL

FRAME DISPLAY SYSTEM

Using straight or curved frames to which graphic panels can be attached by means of magnetic strips, vario d2 has a distinctive appearance. Its seamless connections enable as many frames to be connected as required.

The OCTANORM groove enables other connections to be made. Attractive in its own right, vario d2 can be further enhanced by the use of spotlights and literature racks.

A carrying bag is also available. The system comprises of high quality anodized aluminium profiles that are light weight and easy to assemble.



3 pcs. VA 1275, 2 pcs. M 249, 2 pcs. M 825, 2 pcs. M 1440, 2 pcs. VA 1240, 4 pcs. VA 5038 & 2 pcs. VA 5021
Panel recommendation: from 0.7 mm to 1.0 mm PVC



VA 5021



M 1444



VA 1240



BASIC MODULES:

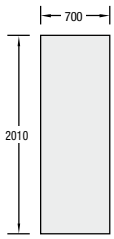

VA 1272
Straight frame

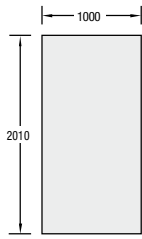

VA 1273
Straight frame

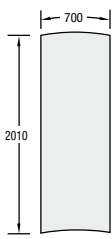

VA 1275
Curved frame

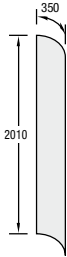

VA 1282
Curved frame 90°

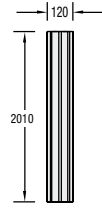

M 249
Round upright
8 grooves

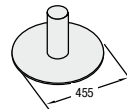

M 825
Base plate grey

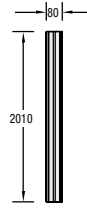

M 1249
Round upright
8 grooves

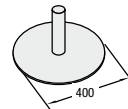

M 1239
Base plate silver-grey

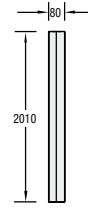

M 1049
Square upright
4 grooves

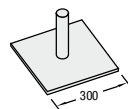

M 1406
Base plate silver-grey

Supplied without panels. Connecting elements are included, dimensions correspond to panel size. System prepared for panels on one side.

ACCESSORIES:



E 14
Hex-star driver

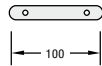

VA 5000
Straight connector
(pack. unit 2 pcs.)

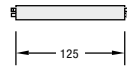

VA 5038
Distance beam



VA 5058
Conical foot

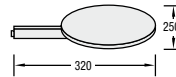

VA 5076
Display shelf
wood, silver

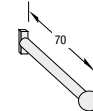

E 275
Bag holder



END PLATES
M 270 for M 249
M 1235 for M 1249
M 1035 for M 1049



VA 1240
Brochure shelf
universal

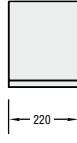

VA 5032
Brochure shelf, right

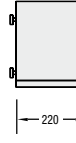

VA 5036
Brochure shelf, left

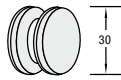

M 1391
Panel retainer
incl. rubber inserts
and M 1470/Ha

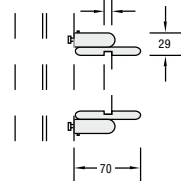

M 1580
Panel retainer
with slot

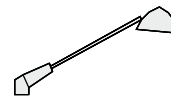

VA 5020
Spotlight
150 W/
230 V

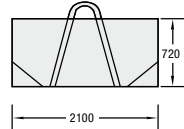

VA 1019
Transport bag



M 1440
Cone wood,
silver



M 1438
Cone wood,
silver



M 1443
End cap
wood, silver

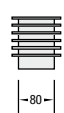

M 1442
End cap
wood, silver

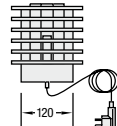

M 1444
Cover lighting
wood, silver
40 W / 230 V



VA 5035
Magnetic strip 30 m
self-adhesive



VA 5045
Steel strip 30 m
self-adhesive

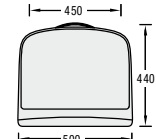

VA 8838
Transport bag for
2pcs M 825

TECHNICAL INFORMATION:

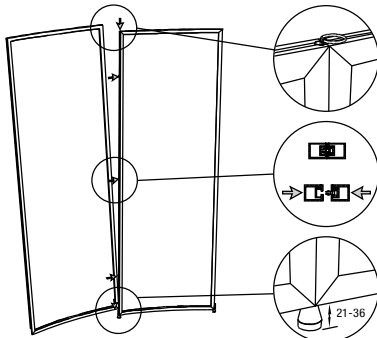

DRAWING EXAMPLES:



VA 1240
Left, right or
front position

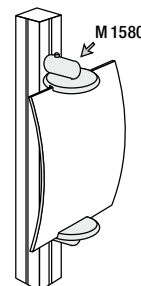

M 1580